

F182T3M4A

General Purpose, Three Phase, Rolled Steel Frame, AC Motor

Energy Efficient – TEFC – Inverter Rated (10:1 Variable -5:1 Constant Torque) -- AC Motor

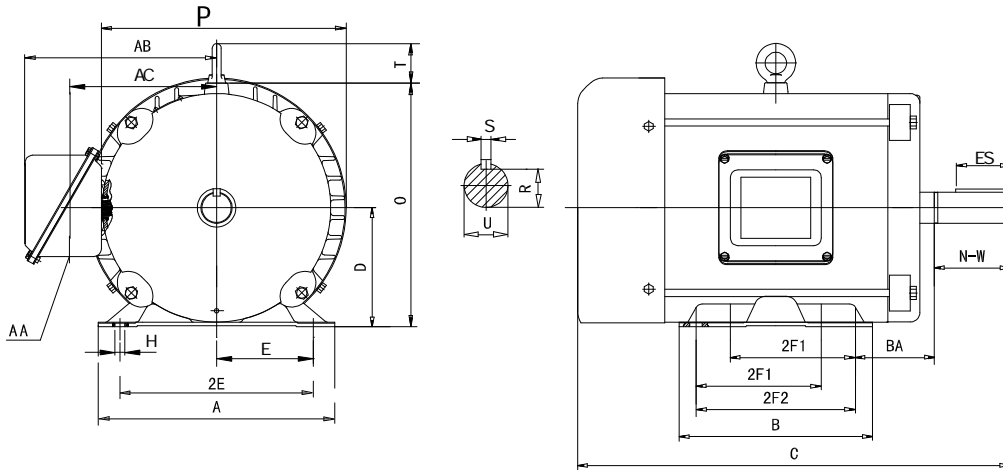

DIMENSIONS – INCHES

A	B	C	D	E	2F1	2F2	G	H	AC	O
9.0	6.7	15.7	4.5	3.75	4.5	5.5	NA	.41	5.7	9.25
P	R	S	T	U	ES	AA	AB	BA	N-W	Mount
10.2	.986	.25	1.97	1.125	1.78	1.10	7.3	2.75	2.75	F1

PERFORMANCE DATA

Three Phase – 60Hz - 208-230/460V – NEMA Design B - Max. Ambient: 40° C

HP	Speed	Frame	NEMA Code	Efficiency (%)			Power Factor			Torque (ft-lb)		
				100%	75%	50%	100%	75%	50%	FLT	BDT	LRT
3	1760	182T	K	87.5	87.2	86.3	75.0	70.1	64.6	9.0	250	215
Amps (460V)		DE Bearing	ODE Bearing	Insulation Class	Enclosure Type	Service Factor	Weight (lbs)					
FLA	LRA											
3.9	32.0	6206ZZ	6206ZZ	F	TEFC	1.15	88					



ElectricalHelper

"Practical Straight Forward Electrical Wiring Solutions Since 1928."

For Fast Friendly Assistance
Call Us 888.226.4917
Hours 8:00AM - 5:00PM